

The background of the entire page features three white, headless mannequins on black stands. The mannequin on the left is seen from the back, wearing a white crop top and skirt. The middle mannequin is seen from the front, wearing a white crop top and skirt, with its hands clasped in front of it. The mannequin on the right is seen from the front, wearing a white crop top and skirt, with its hands resting on its hips. A green fern-like plant in a black pot is positioned in the foreground on the right side, partially obscuring the mannequin on the right.

DANCEWEAR

# EXPO

Virtual Show

FEBRUARY 29-30 2023

Baltimore

FEBRUARY 4- 6 2023

SHOW PROGRAM

# Nikolay®

Made for Legends

# MYSTIQUE

collection

OFFICIAL SPONSOR



DANCEWEAR  
**EXPO**



YOUTH  
INTERNATIONAL  
BALLET  
COMPETITION

Ph. 407-237-9598  
orders@nikolay-world.com

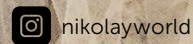

nikolay-world.com

# DANCEWEAR **EXPO**

- 3 - TABLE OF CONTENTS
- 6 - A WELCOME LETTER FROM DANCEWEAR EXPO
- 8 - A THANK YOU TO OUR SPONSORS
- 9 - VIRTUAL SHOW SCHEDULE
- 10 - BALTIMORE SHOW SCHEDULE
- 12 - BALTIMORE SEMINAR SCHEDULE
- 13 - BALTIMORE EXHIBITOR BY BOOTH LISTING
- 15-16- BALTIMORE EXHIBIT HALL MAP
- 17 - 104 ADVERTISEMENTS AND EXHIBITOR INFORMATION





CAPEZIO



# *inspire*

Centuries-old tradition meets cutting-edge technology  
in the pointe shoes handcrafted for every expression.  
See for yourself in booths 104-106.

[virtisse.com](http://virtisse.com)

**virtisse**  
HANDCRAFTED FOR DANCE

# DANCEWEAR EXPO

Dear 2023 Show Attendees:

Welcome to Dancewear Expo 2023. We want to thank our retail partners for helping to make this year's Baltimore Show our best attended show ever. We also want to thank our exhibitors who have gone above and beyond to assure the success of this year's shows with new products, programs, educational content and generous sponsorships. We are in this together to build a stronger business.

This program is a complete directory for both the Virtual and In Person Baltimore Shows. You will find exhibitor listings for both shows. You will also find show schedules, company profiles, contact information, and show specials.

The Resource Center is new for 2023. It was designed to be a reference center for dance retailers. You will find videos that will help you be more knowledgeable about the products that you carry or are looking to carry. Please share these videos with your staff. You will be able to access all Virtual Show content thru April 30th. After April 30<sup>th</sup> Resource Center content will move to the show web site for year-round access - [dancewearexpo.com](http://dancewearexpo.com)

*Roger Leung & Sandy Askin*

d a n c e w e a r e x p o . c o m



# Nikolay®

Made for Legends

OFFICIAL SPONSOR



DANCEWEAR  
**EXPO**

# STREAMPOINTE

## BROAD METATARSAL AREA

Great for shallow feet that are broad throughout metatarsal.

### EASY ROLL-THROUGH



### ELASTICATED BINDING

Ph. 407-237-9598  
orders@nikolay-world.com

 nikolayworld



nikolay-world.com

# DANCEWEAR EXPO 2023

## PLATINUM SPONSORS

**Nikolay**<sup>®</sup>  
Made for Legends

**CAPEZIO**

  
**virtisse**

## GOLD SPONSORS

**BLOCH**<sup>®</sup>

*Ads*<sup>®</sup>  
A PLUS DANCE SHOES

*Glam'r*  
**GEAR**<sup>®</sup>

**LULLI**  
DANCEWEAR

*So Danca*<sup>™</sup>

## SILVER SPONSORS

 **COVET DANCE**

**AK**  
DANCEWEAR

  
*Ballet Rosa*<sup>®</sup>

  
EUROTARD DANCEWEAR  
*for the love of dance.®*

*Body Wrappers*

DANCE DE PARIS  
  
DANCE FASHION

*d.* DANZ\_N MOTION

**Dasha**  
Designs

*elevé*  
dancewear

  
energetiks<sup>®</sup>  
*dance for life*

  
GAYNOR MINDEN<sup>®</sup>  
NEW YORK

  
*girl power*  
sport

*balletogs*

*jule*  
dancewear

  
**MARIIA**

**MERLET**  
MAÎTRE CHAUSSONNIER DEPUIS 1974

**MIGARU**<sup>®</sup>

MONDOR  

  
*Al la la*  
DANCEWEAR

*Pillows*  
FOR POINTES 

  
*Rhino-Stone*  
**BOARD**<sup>®</sup>

*SILKY*  
*Dance*<sup>®</sup>

*lumi*  
COLLECTIVE

**Suffolk**<sup>®</sup>

  
**Aluvie**

**SUPERIOR**  
**STRETCH**  
Products

SWEET  
*wink*

**Wear Mei**  
Designed in France



**VIRTUAL SHOW  
JANUARY 29<sup>th</sup> - 30<sup>th</sup>, 2023**

\*\*\*Virtual Retail Registrants will have access codes / password emailed to their email address that they registered.

**SUNDAY / MONDAY KICKOFF**

Sunday January 29<sup>th</sup>, 2023 12PM - 8 PM EST

Monday January 30<sup>th</sup>, 2023 12PM - 8PM EST

Please note that all virtual exhibitor information will be available to be access for 90 days until April 30<sup>th</sup>.

Also note the deadline dates for each exhibitor's show specials.

**RESOURCE CENTER**

Sunday January 29<sup>th</sup> , 2023 - Sunday April 30<sup>th</sup> 2023

All videos will be available on demand thru April 30<sup>th</sup>, 2023.  
Please share them with your staff.

Additional videos will be added after the Baltimore Show

Click on EXHIBIT HALL to access Exhibitor Booths and Resource Center

**Access Virtual Booths and the Resource Center by clicking on Exhibit Hall, then clicking on each exhibitor (similar to Netflix selection options)**

Ainsliewear  
Ballet Rosa USA  
Baltogs  
Danse de Paris  
Danznmotion by Danshuz  
FLX Stretch Training  
Gaynor Minden  
Girl Power Sport  
Jule Dancewear

Lulli Dancewear  
Lumi  
Mariia  
Merlet North America  
Nikolay  
RP Collection  
Silky Dance  
So Danca  
Sweet Wink

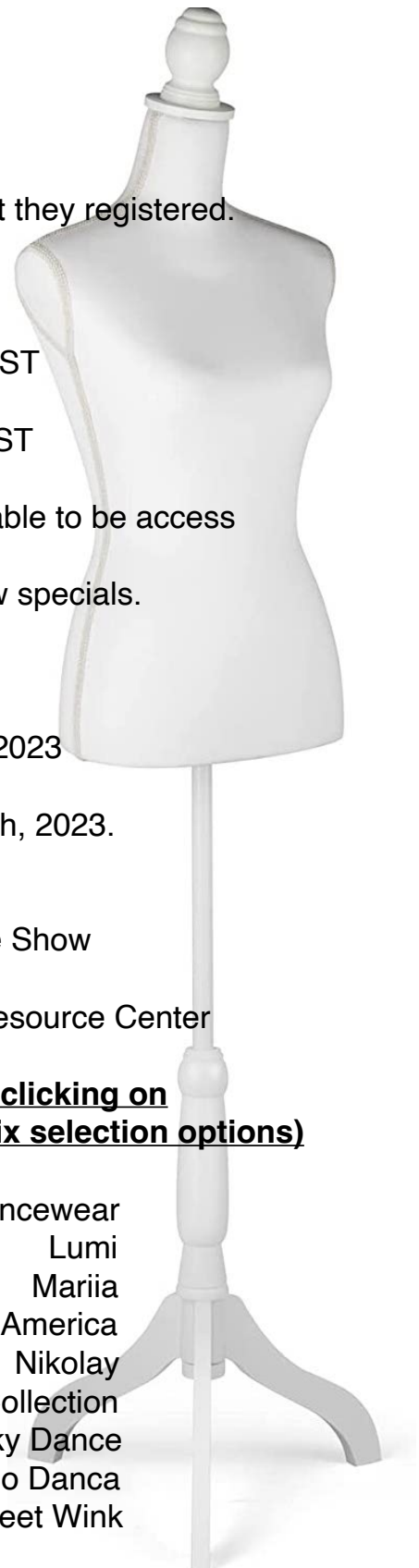

FEBRUARY 4 - 6, 2023  
HILTON DOUBLETREE - NORTH / PIKESVILLE, MARYLAND

## BALTIMORE SHOW SCHEDULE

### SATURDAY February 4<sup>th</sup>, 2023

7:30 am - 9:30 am in Foyer	Breakfast Bar sponsored by Bloch
8:00 am -	Eurotard Seminar*
<b>9:00 am - 6:00 pm</b>	<b>Exhibit Hall Hours</b>
9:15 am -	Virtisse Seminar*
12 pm - 1:30 pm	Lunch (in Restaurant) sponsored by Capezio
12:30 pm -	Capezio Seminar* - Bring your lunch in
3:30 pm - 4 pm	Snack Break (in Foyer) sponsored by Silver Sponsors
4:00 pm -	Suffolk Seminar*
6:15 pm - 7:30 pm	Welcome Party (in Lounge) sponsored by Nikolay

\* Seminars in Pimlico / Laurel Room

### SUNDAY February 5<sup>th</sup>, 2023

7:30 am - 9:30 am in Foyer	Breakfast Bar (in Foyer) sponsored by Lulli and So Danca
8:00 am -	Nikolay Seminar*
<b>9:00 am to 6:00 pm</b>	<b>Exhibit Hall Hours</b>
9:15 am -	So Danca Seminar*
12:00 pm - 1:30 pm	Lunch (in Restaurant) Sponsored by Nikolay
12:30 pm -	Gaynor Minden Seminar* - Bring your lunch in
3:30 pm - 4:00 pm	Snack Break (in Foyer) sponsored by Silver Sponsors
4:00 pm -	Merlet Seminar*
6:15 pm - 7:30 pm	Welcome Party (in Lounge) sponsored by Virtisse

### MONDAY February 6<sup>th</sup>, 2023

7:30 am - 9:30 am in Foyer	Breakfast bar sponsored by A Plus Dance Shoes and Glam'r Gear
<b>9:00 am - 2:00 pm</b>	<b>Exhibit Hall Hours</b>
12:00 pm - 1:00 pm	Lunch in Pimlico   Laurel Room
<b>2:00 pm</b>	<b>Show Closes</b>

HAVE A GREAT YEAR AND SAFE TRAVELS HOME!



# Nikolay®

Made for Legends

OFFICIAL SPONSOR



YOUTH INTERNATIONAL BALLET COMPETITION



DANCEWEAR EXPO

# NEOPOINTE

ONE MODEL –  
TWO DIFFERENT  
LASTS



2007



SmartPointe

## NEO SOFTNESS INSIDEOUT

Soft like a pillow inside and  
the most pliable outside.



[nikolay-world.com](http://nikolay-world.com)



[nikolayworld](https://www.instagram.com/nikolayworld)

Ph. 407-237-9598

[orders@nikolay-world.com](mailto:orders@nikolay-world.com)

## SEMINAR SCHEDULE

Seminars will be in the Pimlico/Laurel Rooms

### SATURDAY February 4th, 2023

8:00 am - Eurotard

"The 2023 Retailer Forum" - Join The Retailer Exclusive Brand for an interactive forum as we discuss maximizing store profits and customer retention with Eurotard's new, innovative products and programs.

9:15 am - Virtisse

"The Virtisse Journey – Model Differences and Choosing the Correct Model"

12:30 pm - Capezio – (bring your lunch in)

"Bunheads & Accessories Product Tutorials and Overview"

4:00 pm - Suffolk

"Proper Placement En Pointe and Introduction of New Pointe Shoe Collection from Suffolk"

### SUNDAY February 5th, 2023

8:00 am - Nikolay

A pointe shoe specialist from Nikolay will go over fitting techniques with new and existing models of Nikolay pointe shoes. We will share with you our take on virtual fittings that have become an industry mainstay. Introduction of new super comfort models.

9:15 am – So Danca

"Removing the risk: If the plan doesn't work change the plan, not the goal. Navigating the uncertain times ahead and taking charge of your business."

12:30 pm - Gaynor Minden – (bring your lunch in)

"Join us as we announce our newest pointe shoe innovations and celebrate our 30th anniversary!"

4:00 pm - Merlet

"Pointe Shoe Composition & Fitting Tips"



## EXHIBITOR LISTING, BALTIMORE 2023

	<u>Booth #</u>
AinslieWear	110
AK Dancewear	407
Aluvie	PF09
American Dance Supply	PF08
Ballet Rosa USA	210-211-212
BalTogs	TC01
Bloch	309-310-311-312
Capezio	306-307-308
Chic Ballet / Oh La La Dancewear	107
CJ Merchantile	PF04
Covet Dance	PF12
Danse de Paris	TC08-TC09-TC10
Danznmotion by Danshuz	303-304-305
Daroch	TC06
Dasha Designs	PF01-PF02
Eleve Dancewear	TC04-TC05
Energetiks (New Exhibitor)	101-102-103
Eurotard	401-402-403
FLX Stretch Training / RP Collection	511-512
Gaynor Minden	413-414
Girl Power Sport	503
Glam'r Gear	PF03
Honeycut	510
Horizon Dance Bags	PF10
Intermezzo	TC07
JoyThru	502
Jule Dancewear	406
Liakada Dancewear	508
Lulli Dancewear	108-109
Lumi	TC03
Mariia	TC02
Merlet North America	404-405
Migaru	507
Mondor	501
Nikolay	208-209-301-302
Oh La La Dancewear	107
Pillows For Pointes Inc	PF05
Pointe People	506
Pretty Girl Cosmetics	509
QT Intimates	PF11
Rhino-Stone	PF07
RP Collection / FLX	511-512
Silky Dance	411-412
So Danca	201-202-203-204-205-206-207
Suffolk Dance LLC	408-409-410
Sweet Wink	PF06
Virtisse	104-105-106
Wear Moi	504-505
Yumiko	513



# Nikolay®

Made for Legends

# MYSTIQUE

collection

OFFICIAL SPONSOR



DANCEWEAR  
**EXPO**



Ph. 407-237-9598  
orders@nikolay-world.com

 [nikolayworld](https://www.instagram.com/nikolayworld)



[nikolay-world.com](https://www.nikolay-world.com)

## MAIN BALLROOM

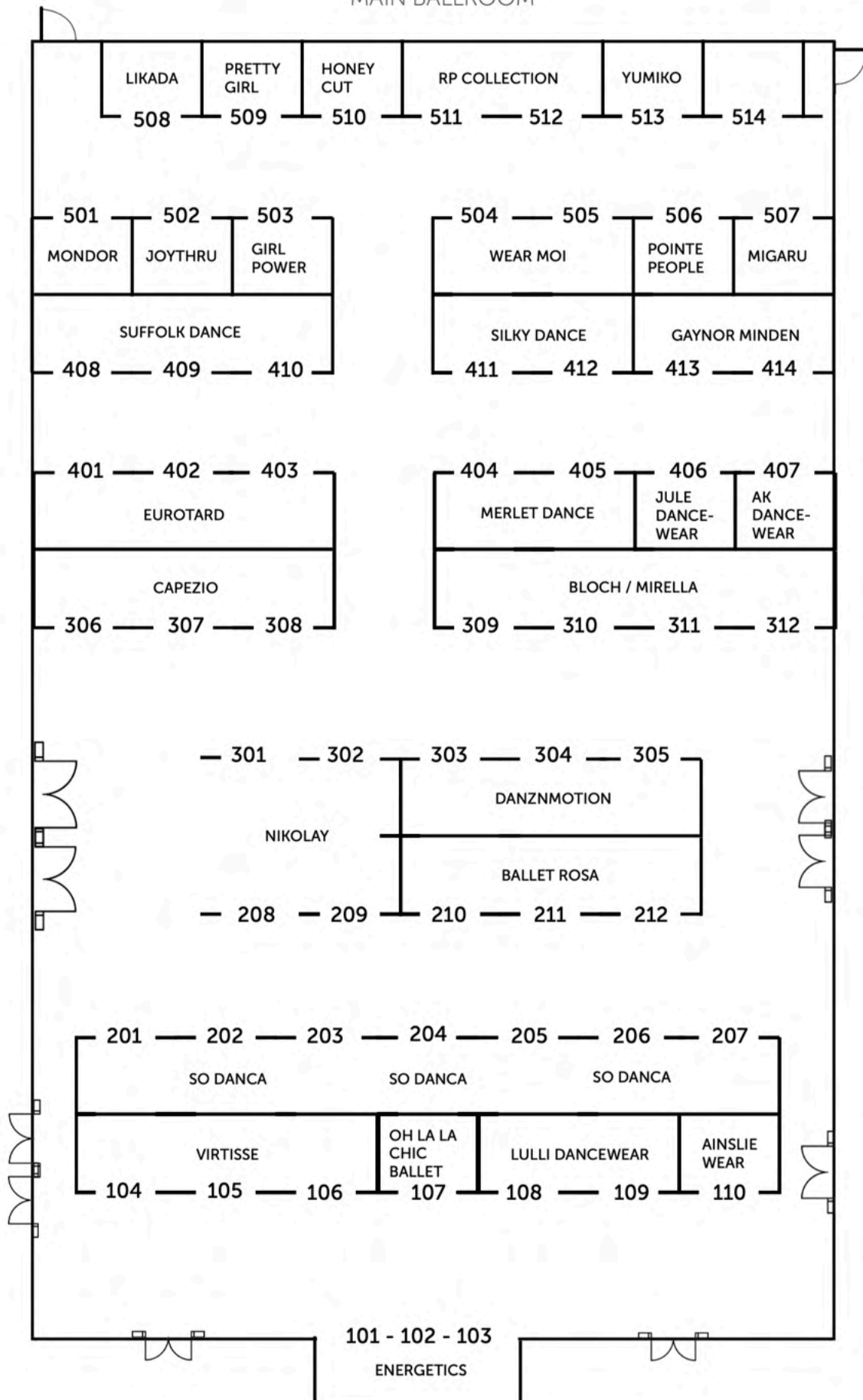

# DANCEWEAR **EXPO**

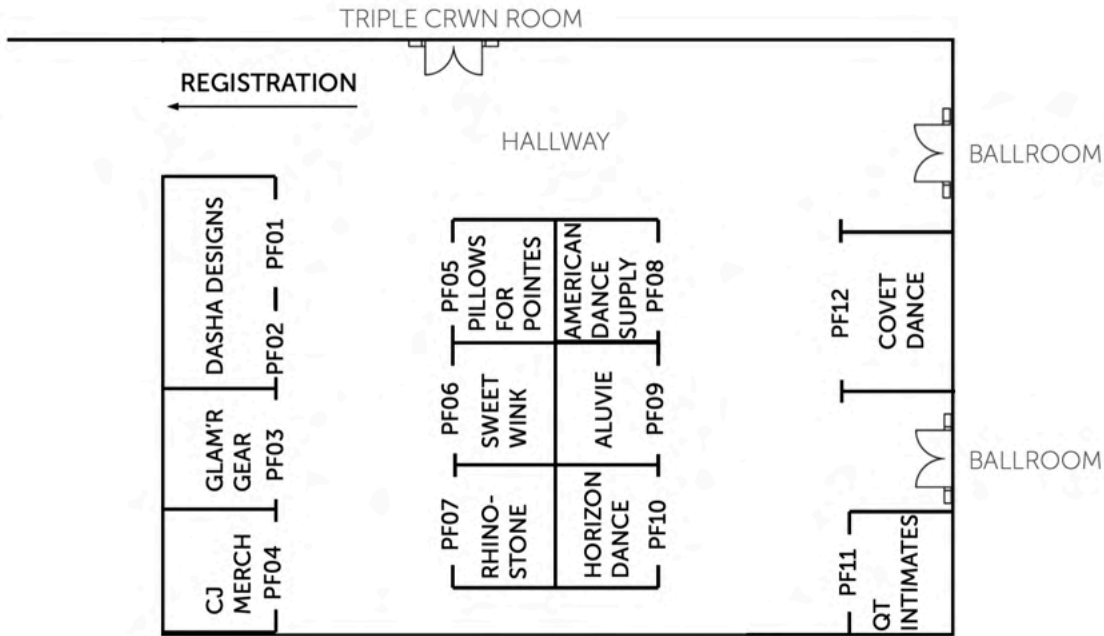
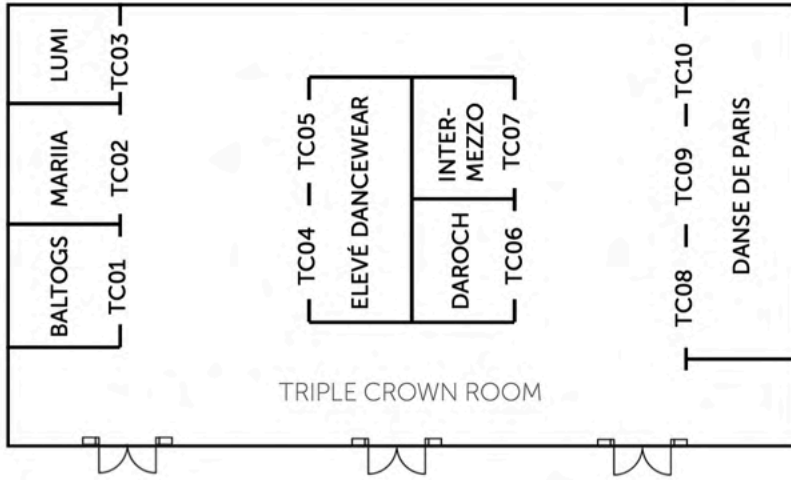





AK Dancewear  
106 N Denton Tap Road – Ste 210-328  
Coppell, TX 75019  
Ph: 817-705-8022  
E-mail: [info@akdancewear.com](mailto:info@akdancewear.com)  
Web site: [www.akdancewear.com](http://www.akdancewear.com)

AK Dancewear is a Texas based ballet dancewear brand producing premium quality, elegant, and timeless designer's dancewear. Our exceptional products continue to expand and include leotards, tops, bottoms, skirts, tights, and accessories.

2023 Dancewear Expo Show specials  
New Account Opening Order \$500  
Free UPS Ground Shipping to the Contiguous US on single orders \$800+  
5% off orders \$800+, 8% off orders \$1,200+, 10% off orders \$1,800+

\*All orders must be placed by end of show.

\*NEW in 2023 - Ask us about [AK Partners program](#) for territory exclusivity and year-long 12% discount with free split shipments!

*Collections*  
by AK Dancewear 





AMD Works & Co  
14439 Ashbury Drive  
Chino Hills, CA 91709  
Ph: 949-529-0038

E-mail: [amdworksllc@gmail.com](mailto:amdworksllc@gmail.com)  
Web site: [www.adsdanceusa.com](http://www.adsdanceusa.com)  
[www.amdworks.com](http://www.amdworks.com)

### **ADS A+ Dance Shoes**

Ballroom dance is centered around the Smooth and Modern grace that sweeps counter clockwise around a wooden ballroom floor as well as the Latin and Rhythm syncopation of dancing in one spot with hot talent and cultural passion. Two types of ballroom dance exist on the ballroom floor and both are empowered and sustained by the foundation of the shoes that carry each dancer through their love affair with the timeless sport of ballroom dance. Aplus Dance Shoes understands the specific needs that the feet of ballroom dancers need. The leather soles and crafted heels are made with the understanding of how a dancers feet must connect to the ground, maintain connection with the foot and slide gracefully with accuracy under every toe through pattern transitions and figures. Our shoes are designed to endure relentless rehearsals and energetic performances as well as casual social dancing and overall quality footwear for men and women.

**Show Special:** BOGO when you mention Sandy or Roger



# AMD WORKS

ADS DANCE

LIBERTY DANCE

CALL OR TEXT : 949-529-0038

EMAIL: AMDWORKSLLC@GMAIL.COM

**BOGO DISCOUNT  
WHEN YOU MENTION  
SANDY OR ROGER!!!**



**CONGRATS TO OUR WINNER AT  
BROWN BALLROOM TEAM  
RYAN AND ELIZABETH**





**Aluvie**

Aluvie (Koo LLC)  
31805 Temecula Parkway #767  
Temecula, CA 92592  
Ph: 951-271-2635  
Email: [info@americandancesupply.com](mailto:info@americandancesupply.com)  
Web site: [www.americandancesupply.com](http://www.americandancesupply.com)

Aluvie

Description: Premium leg warmers made with care and love.

Show special:  
10% off for show orders

Baltimore Exhibitor



# *Comfort & Warmth*

Premium dancewear



# Aluvie

[www.aluviewear.com](http://www.aluviewear.com)

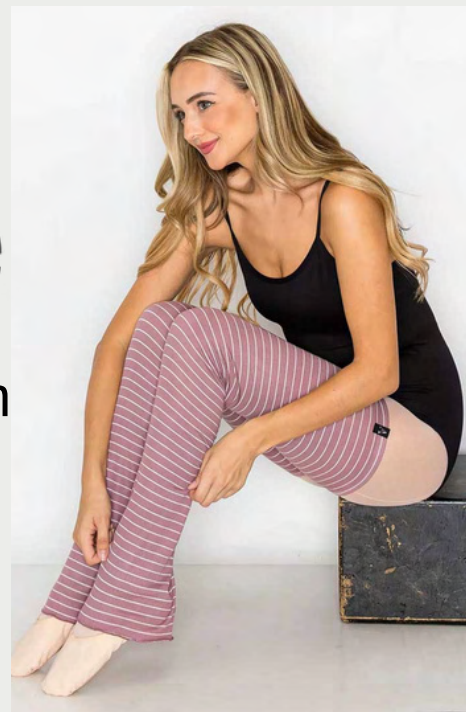

# American Dance Supply

American Dance Supply  
31805 Temecula Parkway #767  
Temecula, CA 92592  
Ph: 951-271-2635  
Email: [info@americandancesupply.com](mailto:info@americandancesupply.com)  
Web site: [www.americandancesupply.com](http://www.americandancesupply.com)

## **American Dance Supply**

**Profile:** Wholesale dance and fitness related products.

### **Show special:**

10% off for show orders

**Baltimore Exhibitor**



Ballet Rosa USA LLC  
2114 Central Street  
Evanston, IL 60201  
Ph: 312-439-6733  
E-mail: [usa@balletrosa.com](mailto:usa@balletrosa.com)  
Web site: [www.balletrosa.com](http://www.balletrosa.com)

## **Ballet Rosa**

Since 2010, the Ballet Rosa name has been known for providing dancers with elegant apparel through fine dancewear stores. Each garment is artfully designed, drawing inspiration from high fashion and infused with European craftsmanship, resulting in the ultimate balance of style and function. The pieces which use high quality fabrics including soft microfiber, ornate lace, and sleek mesh, are made to inspire dancers to express their artistry through movement.

This year, Ballet Rosa proudly introduces the new 2023 Createur collection, featuring new styles inspired by Rococo and Gilded age motifs and broadening color options to inspire dancers around the globe.





**2023 Premier  
Sponsor**



For inquiries, please email  
**[usa@balletrosa.com](mailto:usa@balletrosa.com)**  
or call +1 (312) 439-6733

**[balletrosa.com](http://balletrosa.com)**



Dance Distributors: BalTogs and  
Watercolour  
22840 Savi Ranch Parkway  
Yorba Linda, CA 92887  
Ph: (714) 970-0462  
E-mail: [esther.szassz@outlook.com](mailto:esther.szassz@outlook.com)  
Web site: [www.dancedistributors.com](http://www.dancedistributors.com)

## **BalTogs**

Discover elemental pieces to inspire dreams and push the limits of movement, form and function. BalTog's affordable, performance-first pieces are created to move with your body so you can transform. Break boundaries. Every day. For every dancer.

### WATERCOLOUR

SHE IS WATER. FLUID. BOLD. BEAUTIFUL.

Inspired by the movement of water and the brilliance of colour, Watercolour Dancewear captures a dancer's spirit with its one-of-kind hand-painted designs. With functionality disguised as elegance, every garment accentuates movement and enhances fluidity. Make a statement. Let your colours shine and the rhythm of water set you free.

## **DANCE DISTRIBUTORS --- DANCEWEAR BUYING REIMAGINED**

Join Dance Distributors to find all your top brands under one roof. From ballet to tween fashion, we are committed to providing you with 20+ launches per year. Boost your sales with digital marketing tools, live inventory, and on-demand showrooms. Refresh your store selection any time of the year, manage your orders and stay on top of your deliveries.

### **Show Special**

- 1) Schedule an appointment with Dance Distributors' using the Calendly app and be eligible for a raffle to win \$250 credit towards your full priced order. A winner will be selected daily!
- 2) Place order(s) for \$750 or more on either Mariia, BalTogs, or Watercolour orders before the end of day February 10<sup>th</sup>, and receive 10% off the amount. Lumi is only sold at full price, but if you order \$750 or more of Lumi, orders for the other brands will be eligible for 10% no minimum.

CONTACT: MICHAEL LEE email: [mlee@dancedistributors.com](mailto:mlee@dancedistributors.com) phone: 732-233-3908

**Virtual and Baltimore Exhibitor**



**BodyWrappers / Angelo Luzio**  
107 Trumbull Street  
Elizabeth, NJ 07206  
Ph: 908-354-7218 Fax: 908-354-4023  
E-mail: [info@bodywrappers.com](mailto:info@bodywrappers.com)  
Web site: [www.bodywrappers.com](http://www.bodywrappers.com)

## **Body Wrappers**

Body Wrappers is an American dancewear manufacturer, is known for its brands totalSTRETCH™ Tights, the Premiere™ leotard collection that includes Tiler Peck Designs™, Princess Aurora™ dancewear for little girls, ProWEAR™ basics, totalSTRETCH® Tights & Bodyliners, and its extended collection of liturgical praisewear. Body Wrappers manufactures dancewear for a variety of dance disciplines that includes ballet, jazz, modern, lyrical, contemporary, team and liturgical.

Founded in 1981 and owned by President Marie West, creator of the first one-piece wrap-around-the-body garment (thus the name Body Wrappers), the company now forty years old, has grown to become a leading global brand.

**Non-Exhibiting Sponsor**

# Body Wrappers®

2023

Dear Customer,

Due to the ongoing effects of the pandemic, recession and changing buying patterns, we made a carefully thought out decision for 2023. We feel it is best to engage with our clients via direct communication, the B2B, newsletters, catalogs and social media.

Over a decade ago, Body Wrappers was one of the first vendors to support, encourage and sign up for the Atlantic Dance Retail Show. This year, we are not attending the show but instead focusing on continuing to rebuild and restock our inventory with everyone's favorite products. We are sure this announcement is welcome news to all who buy and depend on Body Wrappers fine quality dancewear.

Body Wrappers has committed to be the go-to company for in-stock dance basics, and we are moving forward with this goal. You will begin to see this promise come to fruition as we move through 2023.

Thank you for being a loyal BW customer throughout our 43 years in business. We look forward to your feedback and continued dedication.

Your Dedicated,

**Sales & Management Teams**



**VOLUME 129**  
B2B 2023

**CONTENTS**

- 3 LEGWEAR & BODYLINERS
- 27 ESSENTIALS
- 49 DANCE BASICS
- 61 PREMIERE
- 65 DANCELEISURE™
- 77 MENS & BOYS
- 85 LITURGICAL
- 89 SIZE CHARTS

Body Wrappers®



**VOLUME 129**  
**NOW AVAILABLE**

**REFER TO YOUR SALES REP OR BW'S B2B**

**BLOCH®**

**Bloch**

1170 Trademark Drive #112

Reno, NV 89521

Ph: 775-824-2550 Fax: 775-824-2551

Email: [usa-orders@bloch.net](mailto:usa-orders@bloch.net)

Web site: [www.blochworld.net](http://www.blochworld.net)

**Profile:**

At BLOCH, our goal is to equip dancers with the dancewear solutions, clothes, shoes, and accessories they need to perform at their absolute best. Our range spans from beginner dancewear to professional dance shoes, helping all dancers reach new levels. We have ballet shoes, ideal for young dancers beginning their dance career, or professional pointe shoes for those ready to take their dancing to the next level.



LISTENING TO DANCERS  
SINCE 1932



**BLOCH**

# CAPEZIO

Capezio  
One Campus Road  
Totowa, NJ 07512  
Ph: 888-227-3946  
Email: [info@capezio.com](mailto:info@capezio.com)  
Web site: [www.capezio.com](http://www.capezio.com)

## **Profile:**

Capezio, established in New York, is your go-to dance wear brand. Since 1887 we have provided high quality dance shoes, apparel and accessories made for movement. Today our products are available worldwide and aim to keep you dancing through life.

## **Show specials:**

1) Core Special - 10% off, 5% freight, 60-day terms, Min order \$2,000+

Excludes Swing Fashion, New Core items, Closeouts, SMU

2) 1626W/C Transition Tight Special -

1626W Wholesale \$7.50 MSRP \$15.00

1626C Wholesale \$6.50 MSRP \$13.00

Buy <48 pairs = can be included on Core Special order 10% discount

Buy 48+ pairs = 20% discount

Buy 96+ pairs = 30% discount

Buy case packs (240 per sku) = 40% discount



CONFIDENT IN

CAPEZIO



**CJ MERCHANTILE**

CJ Merchantile  
PO Box 80702  
Seattle, WA 98108.  
Ph: 206.304.6891  
Email: [cjmerchantile@gmail.com](mailto:cjmerchantile@gmail.com)  
Web site: [www.cjmerch.com](http://www.cjmerch.com)

**Profile:**

Accessories and Gift Items for Dancers

**Show Specials**

Show Specials 5% Discount for orders placed at the show in Baltimore

**Baltimore Exhibitor**



Covet Dance

4023 Camino Ranchero, Ste F

Camarillo, CA 93012

Ph: 805-484-4199

Email: [sharene@covetdance.com](mailto:sharene@covetdance.com)

Web site: [www.covetdance.com](http://www.covetdance.com)

**Profile:**

We design and create unique, aspirational and relatable products for the young dancer. From original apparel design, dance bags and water bottles to our handcrafted collection of balms and self-care products, the Covet line is priced to generate PLUS+ business for your store with minimal time commitment to ordering and stocking.

**Show Specials:**

Free shipping on orders over \$500 placed at show



**COVET DANCE**

Relatable lifestyle products  
just for dancers.



**Easy PLUS BUSINESS**  
for dance & specialty stores.



[COVETDANCE.COM](http://COVETDANCE.COM)



Danse De Paris  
10 Prince Street  
Mosman, NSW 2088 Australia  
Ph: +1 604 791 6209  
E-mail: [sales@dansedeparis.com](mailto:sales@dansedeparis.com)  
Web site: [www.dansedeparis.com](http://www.dansedeparis.com)

## **DANSE DE PARIS**

Danse De Paris' designs are created with an understanding that the perfect line creates confidence on and off the stage. Using only the highest quality stay dry fabrics, Danse De Paris' leotards are sensitive to the wearer with performance, comfort, and fashion in mind. Designed by dancers for dancers of every shape and size. Danse De Paris igniting confidence.

### **Show Special:**

Purchase 50 leotards and receive 5 complimentary leotards of your choice.

Purchase 75 leotards and receive 11 complimentary leotards of your choice.

Purchase 100 leotards and receive 20 complimentary leotards of your choice.

\*All orders must be received in their entirety by 5 pm PST February 13, 2023.

\*For ALL ORDERS consisting of multiple delivery dates, complimentary leotard will be included in the final shipment which must be shipped before May 1<sup>st</sup>, 2023.



DANSE DE PARIS  
DANCE FASHION

[WWW.DANSEDEPARIS.COM](http://WWW.DANSEDEPARIS.COM)  
@WEARDANSEDEPARIS



Danznmotion by Danshuz  
539W.Walnut Avenue – Suite B  
Orange, CA 92868  
Ph: 800-886-7914 Fax: 714-516-9753  
E-mail: marlo@danshuz.com  
Web site: www.danshuz.com

## **Profile**

DanzNmotion in business since 1955. Featuring a complete line of quality dance products for the dance retailer at fair prices and all in stock for quick delivery. In addition to our extensive line of bodywear and shoes, we also offer the largest and most diversified dance bag collection in the world for both the professional and the aspiring young dancer. We appreciate the trust our customers have shown us over the years by bringing our products into their stores; and moreover, allowing us to continuously grow year after year. True quality, excellent value and a great customer experience is at the heart of who we are.

Dancing in Motion Since 1955

## **Show Special**

\$500.00 MINIMUM - 6% Discount on all "New 2023" Shoes, Bodywear & Bags

\$1,000.00 MINIMUM - 8% Discount on all "New 2023" Shoes, Bodywear & Bags

\$1,500.00 MINIMUM - 12% Discount on all "New 2023" Shoes, Bodywear & Bags

\*Discount only available on "NEW 2023" styles (all style numbers starting with 23)

\*Orders must be turned in by end of show to qualify for discount, no exceptions please.

# 2023 Collection

*Now available.*

Please visit our booth or call  
for an instore appointment.





Daroch Dance  
Tuxpan 120  
Guadalupe, Nuevo Leon México 67140  
Ph: +52 1 8112771772  
E-mail: [info@darochdance.com](mailto:info@darochdance.com)  
Website: [www.darochdance.com](http://www.darochdance.com)

#### **COMPANY PROFILE:**

DAROCH is a Mexican dance wear brand that seeks to highlight the individuality of each dancer. We believe dance can empower young girls while simultaneously providing creative means of expression. At DAROCH we want our designs to make dancers feel powerful, fierce and unique. Our products are 100% made in Mexico, our years of expertise in the dance industry guarantee that all of our customers' needs will be met.

Our monthly new releases keep customers excited and always looking for the new fresh outfits. In-stock inventory available and custom order options. Our product categories include: leotards, tops, shorts, joggers, leggings, shirts, bikers and ballet shoes.

#### **SHOW SPECIALS:**

5% DISCOUNT ON ORDERS OF \$1,000

10% DISCOUNT ON ORDERS OF \$2,000

\*Orders must be placed by February 20, 2023 to receive the discount.

**Baltimore Exhibitor**





Dasha Designs LLC  
2311 East Grauwlyer Road  
Irving, TX 75061  
Ph: 800-543-2742  
E-mail: [info@dashadesigns.net](mailto:info@dashadesigns.net)  
Web site: [www.dashadesigns.net](http://www.dashadesigns.net)

## Dasha Designs

Dasha Designs has been in business since 1984, redefining and reinventing itself to always bring the best to our customer. Many of our products are designed and manufactured exclusively by Dasha, which means they are not available elsewhere. We carry accessory items primarily for the dancer, but also carry items for gymnastics, skating, and cheer leading. We are the experts and have the best offering of dance accessories and gifts because that's all we do.

We have 9 products lines which include:

Bags	Figurines	Jewelry
Basics	Gift and Room Décor	Leotards
Cosmetics	Hair Accessories	Skirts / Tutus

Show Special:

10% off orders over \$300, Special Show pricing on select items located throughout the booth, free gift when placing an order.



1984

Dasha  
Designs

2023



COME VISIT US AT:  
BOOTH FP01 & FP02



- \*BAGS
- \*COSMETICS
- \*HAIR ACCESSORIES
- \*PLUSH
- \*FIGURINES
- \*JEWELRY
- \*SKIRTS  
AND MORE...



800-543-2742 FAX: 972-554-6464

WWW.DASHADESIGNS.NET



Eleve Dancewear  
301 East 31st Street  
Kansas City, MO 64108  
Ph: 816-283-7200  
E-mail: [shelley@elevedancewear.com](mailto:shelley@elevedancewear.com)  
Web site: [www.elevedancewear.com](http://www.elevedancewear.com)

### **Eleve Dancewear**

A company that specializes in making dancers clothing that is comfortable and stylish, for the professional dancer and student, but also give them the confidence to dance and look their best. Have fun, be creative, and let your inner designer emerge. Wear Elevé and you will get noticed!

# elevé

dancewear



[www.elevedancewear.com](http://www.elevedancewear.com)



Energetiks  
19 McGregor Drive  
Keilor Park, VIC (Victoria) Australia 3042  
Ph: +61 407 331020  
Email: [karen@energetiks.com.au](mailto:karen@energetiks.com.au)  
Web site: [www.energetiks.com.au](http://www.energetiks.com.au)

## **Energetiks**

### **Profile:**

Dance for Life - Our mission at Energetiks is to inspire and support dancers to perform well and live well.

From humble origins beginning with a small storefront in Melbourne, Victoria in 1988 Energetiks has steadily grown into Australia's leading dancewear brand trusted by dancers worldwide. Guided by the vision of founders Gail, Lynda and Karen. Energetiks' unwavering passion and commitment to empower dancers to live well and perform well has shaped the company into the internationally recognised brand it is today.

Though much has changed, our lifelong commitment to provide the very finest Australian Made Dancewear remains.

### **Show Specials:**

10% off all orders submitted during the show.

**Baltimore Exhibitor**

The logo for 'energetiks' features a stylized red figure in a dynamic, athletic pose above the brand name in a lowercase, sans-serif font.

AUSTRALIAN MADE, OWNED & DESIGNED.





## EUROTARD DANCEWEAR

Eurotard Dancewear  
1328 Union Hill Road  
Alpharetta, GA 30004  
Ph: 770-475-3045 Fax: 770-664-7208  
E-mail: [jan@eurotard.com](mailto:jan@eurotard.com)  
Web site: [www.eurotard.com](http://www.eurotard.com)

### **Eurotard Dancewear**

Quality. Design Passion.

Three words that define the core of Eurotard Dancewear:

**Quality:** Our superior materials and skilled workmanship provide comfortable, durable and well-fitting products.

**Design:** Our products, store-exclusive programs and pricing are designed to aid in the success of our brick and mortar retailers.

**Passion:** Our team's passion transcends in all we do; from service to shipping and everything in between.

### **Show Special**

Contact your sales representative or visit the booth for show special information.



# EUROTARD DANCEWEAR

Quality. Design. Passion.



The Retailer Exclusive Brand  
Supporting stores, not competing with them.

[eurotard.com](http://eurotard.com) | [sales@eurotard.com](mailto:sales@eurotard.com)

*for the love of dance.®*





Gaynor Minden Inc.  
140 West 16th Street  
New York, NY 10011  
Ph: 212-929-0087 Fax: 212-929-4907  
E-mail: [orders@dancer.com](mailto:orders@dancer.com)  
Web site: [www.dancer.com](http://www.dancer.com)

### **Gaynor Minden Inc.**

A New York-based family business, Gaynor Minden, Inc. makes internationally-renowned pointe shoes, elegant studio apparel, and inspired accessories. Made from super-durable, impact-absorbing, noise-reducing materials, Gaynor Minden pointe shoes are used by leading ballerinas at the world's most important companies, recommended by indisputably great teachers, and validated by independent scientific studies.

### **Show Special**

10% off \$1,000, and 12% \$2,000  
Orders must be placed by end of show.

IT'S AMAZING WHAT GOES INTO  
MAKING SOMETHING EFFORTLESS.



GAYNOR MINDEN®

NEW YORK ♦ SINCE 1993

GILLIAN MURPHY, Principal Dancer at American Ballet Theatre,  
has been wearing *Gaynor Minden* pointe shoes since she was fifteen.

[DANCER.COM](http://DANCER.COM)



Girl Power Sport  
7683 SE 27th Street #416  
Mercer Island, WA 98040  
Ph: 425-736-1056  
E-mail: [lisa@girlpowersport.com](mailto:lisa@girlpowersport.com)  
Web site: [www.girlpowersport.com](http://www.girlpowersport.com)

### **Girl Power Sport**

Girl Power Sport has a singular, simple belief: girl power can change the world through kindness, by giving back to the society which allows them to compete. All of our products are made in Washington state by women who are passionate about encouraging goal driven and active youth. We believe in creating leotards and activewear that is ecologically sound and socially aware. Girl Power Sport is gymnastics driven with bold custom prints that will take you from the field to the studio or the gym and beyond. Our sizes range from child 4/5 through adult small. We donate \$1 to charity from every item that is sold from our site. If you love dogs, cats, koalas, rainbows or unicorns then this is the brand for you! We offer custom orders with no minimums and we ship quickly. Thank you for your support of Girl Power!

### **Show Special**

Krazy Kat Leotard \$18 show special  
Krazy Kat Sports Bra \$15 show special  
Krazy Kat short \$15 show special

**Virtual and Baltimore Exhibitor**

The logo for 'girl power sport' features a stylized pink heart with a girl's silhouette inside, positioned above the text. 'girl power' is written in a bold, purple, lowercase sans-serif font, and 'sport' is written in a smaller, green, lowercase sans-serif font below it.

**girl power**  
sport

Made in the USA





Glam'r Gear  
12222 Blue Ridge Extension  
Grandview, MO 64030  
Ph: 816-875-9887  
E-mail: [glamrgear@gmail.com](mailto:glamrgear@gmail.com)  
Web site: [www.glamrgear.com](http://www.glamrgear.com)

**Profile:**

Glam'r Gear® Features the Most Popular Dance Bag\* with Privacy Features - US Patented!  
Changing Stations, Demi Foldable bag with garment rack, and Solo™ Carry On Bags,  
backpacks and all the Related accessories! Our mission is empowering dancers, performers,  
and more with amazing gear!

**Show Special**

FREE SHIPPING (Up to \$100 Value).

Glam'r  
**GEAR**®

#goforitwithstyle

#glamrgear

## A Must-Have for Dancers!!!



US patented products.

Our mission is to empower dancers,  
performers and athletes by offering amazing gear.

[www.glamrgear.com](http://www.glamrgear.com)  
[glamrgear@gmail.com](mailto:glamrgear@gmail.com)

 [glamrgear](https://www.facebook.com/glamrgear)

 [glamrgear](https://www.instagram.com/glamrgear)



Honeycut  
2060 Placentia Avenue # C-2  
Costa Mesa, CA 92660  
Ph: 947-478-1960  
E-mail: [honeycutofficial@gmail.com](mailto:honeycutofficial@gmail.com)  
Web site: [www.honeycutofficial.com](http://www.honeycutofficial.com)

## **Honeycut**

HONEYCUT® is focused on creating authenticity between the product and the dancer athletes who inspire us every day. Meet the “sweet fit” of HONEYCUT® and our approach to dance lifestyle.

From the HIVE, located in Southern California, we conceive and curate this contemporary dance and fitness wear for teens & tweens. Channeling our love of movement, saltwater and a naturally boho beach lifestyle, the collection combines form + function and brings an ever-fresh perspective to the dynamic dance world.

Always inspired by our art form, adventure and the allure of all things So-Cal, our signature aesthetic has been created. This style is undeniably HONEYCUT®. Our brand name, when broken down, means “sweet fit” and reaches beyond the studio. HONEYCUT® is a highly researched and tested brand, always in step with the direction dance is taking. It’s a ready-to-wear-anywhere collection, vibing individuality and blending seamlessly between studio and street.

Our product is designed in California and made all over the world.



Horizon Dance Bags  
13446 Poway Road, Unit 216  
Poway, CA 92064  
Ph: 858-679-7920  
Email: [horizondance2@gmail.com](mailto:horizondance2@gmail.com)  
Website: [www.horizondance.com](http://www.horizondance.com)

### **Horizon Dance**

As Horizon Dance celebrates its 37<sup>th</sup> anniversary, we are proud to remember the things that makes us unique as a dance bag wholesaler. We are woman-run business, and our products have a large and growing variety of designs, all designed by us.

We have cute totes and duffels for the little ballerinas. More functional gear duffels and backpacks are offered for older dancers. We also carry blank gear duffels and garment bags for teams.

Our small size allows us to process orders and customer requests quickly and our prices remain highly competitive. We are a true wholesaler and can focus on our customers, rather than doing any retail business. Our focus is on providing excellent customer service and high-quality products.

### **Show Special**

10% off orders over \$350





Intermezzo by Malltex S.A.

Borges Banques, 86

Terrassa, Spain 08227

Ph: +34 648 086486

E-mail: [info@intermezzo.es](mailto:info@intermezzo.es)

Web site: [www.intermezzo.es](http://www.intermezzo.es)

### **Intermezzo**

At intermezzo we design, manufacture and sale dancewear for all disciplines. Malltex, S.A. was born in 1927 since then the company has been focused on dancewear. We offer a large range of products and our knitwear in particular offers really unique garments. We have a beautiful leotard collection and all kind of accessories for dancers.

Dance is an art and Intermezzo makes your dreams come true. Quality, comfort and beauty are our values and essence. Art requires creativity and discipline, take care of all details and love what you do. We do our best to offer excellent products an on time service.

We take care of our collections. Designed and produced at our local headquarters in Terrassa, Barcelona. Local and proximity production is a priority for us. In this way, we can apply an exhaustive quality control and be responsible throughout the production process.

### **Show Special:**

5% to all orders placed at the show (minimum order 500USD)

**Baltimore Exhibitor**

# JoyThru™ Dance

JoyThru Dance  
653 Cumberland Way  
Webster, NY 14580  
Ph: 585-217-1866  
E-mail: [info@joythru.com](mailto:info@joythru.com)  
Web site: [www.joythru.com](http://www.joythru.com)

## **JoyThru™ Dance Bag**

### **Profile:**

Women-owned and proud!

When two determined dance parents saw how damp clothes and delicate shoes got stuffed together in dance bags, with chemical fresheners disguising the odor, they resolved to find a better way –and JoyThruDance was born. Sarah Joy and Maureen Throumoulos struck up a friendship, and later a business, during their daughters' dance classes. Discussing the strong smell of ballet feet, the serious investment in dance essentials, and the scramble of dance life led to the concept and design of the JoyThruDance carrying bag/storage unit and reVIVE packs of activated charcoal.

With the detailed precision and conscious intention that define the dancer lifestyle, JoyThruDance protects the essentials, the time and the well-being of dancers everywhere.

**Baltimore Exhibitor**



Jule Dancewear  
2412 Hardwick Street  
Dallas, TX 75208  
Ph: 214-280-5341  
E-mail: [info@juledancewear.com](mailto:info@juledancewear.com)  
Web site: [www.juledancewear.com](http://www.juledancewear.com)

**Profile:**

Self-love, confidence, and body positivity. These are the founding principles of Jule Dancewear (@juledancewear), the premier dancewear and activewear line founded and run by former Miami City Ballet dancer, Julia Cinquemani (@julia\_cinquemani). Established in 2011, Julia addressed a need in the dancewear space: apparel that catered to women of all shapes, offering them the functionality they need without compromising fashion and quality. All Jule products are proudly made in the USA.

**Show Special**

10% off orders of \$3,000 or more.

jule



meshies  
Collection



Scan to shop



Liakada Dance by Covalent Activewear  
7190 Oakland Mills Road – Suite 5-6  
Columbia, MD 21046  
Ph: 410-381-1900  
E-mail:

[lincolntran@covalentactivewear.com](mailto:lincolntran@covalentactivewear.com)

Web site: [www.liakadadance.com](http://www.liakadadance.com)

## **Liakada Dancewear**

Liakada Dancewear is proud to be a premium dance wear apparel brand with a mission to provide well-made, durable, and perfect-fitting products. Based just outside of Baltimore, Maryland, we are proud to be a woman-owned, family-run small business. All of our offerings are made from the highest quality motion wear stretch fabrics and we are proud of our attention to detail with construction quality and durability. Our unique modern styles and colors are sure to please the pickiest dancers while being affordable and long-lasting.

Visit our website to view our full collection of dancewear products at:

[www.liakadadance.com](http://www.liakadadance.com)

## **Show Special**

New Customer Sign-ups at the show will enjoy a 20% discount off their entire order.

Existing customer orders at the show can take advantage of 15% discount off their entire order.

All orders at the show will receive a free one-time use 5% discount coupon code for their next purchase after the show.

## **Baltimore Exhibitor**

# LULLI

Lulli Dancewear by A.R. Refael Trade Ltd.

5 Tel Giborim Street

Tel Aviv, Israel 6810519

Ph: +972-54-6244029

Fax: +972-3-5136909

E-mail: [sales@lulldancewear.com](mailto:sales@lulldancewear.com)

Web site: [www.lulldancewear.com](http://www.lulldancewear.com)

## **Lulli Dancewear**

LULLI produces basic and performance dancewear such as leotards, pants, tops, skirts, tights and unitards. We use only the finest fabrics, each carefully selected and applied to breed the perfect look n' feel – Microfiber, Nylon, Lycra and Cotton Lycra with a velvet touch by DuPont.

All leotards include an inner bra to ensure maximum support while dancing, and all products are tested by professional dancers before marketing.

## **Show Special**

5% for \$ 1,000

10% for \$ 2,000

15% for \$ 4,000

Plus free shipping.

**Virtual and Baltimore Exhibitor**

# LULLI

DANCEWEAR



[LULLIDANCEWEAR.COM](http://LULLIDANCEWEAR.COM)



Dance Distributors: BalTogs and  
Watercolour  
22840 Savi Ranch Parkway  
Yorba Linda, CA 92887  
Ph: (714) 970-0462  
E-mail: [esther.szassz@outlook.com](mailto:esther.szassz@outlook.com)  
Web site: [www.dancedistributors.com](http://www.dancedistributors.com)

## **LUMI COLLECTIVE**

LET YOUR LIGHT SHINE BRIGHT

LUMI creates fresh lifestyle looks for today's active teen. From dancing to having fun these functional activewear pieces are inspired by fashion trends that are sure to brighten your day. Flush with fresh color palettes and fun, stylish prints, these styles will compliment any dancer's wardrobe. Experience ultimate freedom and flexibility.

## **DANCE DISTRIBUTORS --- DANCEWEAR BUYING REIMAGINED**

Join Dance Distributors to find all your top brands under one roof. From ballet to tween fashion, we are committed to providing you with 20+ launches per year. Boost your sales with digital marketing tools, live inventory, and on-demand showrooms. Refresh your store selection any time of the year, manage your orders and stay on top of your deliveries.

### **Show Special**

- 1) Schedule an appointment with Dance Distributors' using the Calendly app and be eligible for a raffle to win \$250 credit towards your full priced order. A winner will be selected daily!
- 2) Place order(s) for \$750 or more on either Mariia, BalTogs, or Watercolour orders before the end of day February 10<sup>th</sup>, and receive 10% off the amount. Lumi is only sold at full price, but if you order \$750 or more of Lumi, orders for the other brands will be eligible for 10% no minimum.

CONTACT: MICHAEL LEE email: [mlee@dancedistributors.com](mailto:mlee@dancedistributors.com) phone: 732-233-3908



Four young women are posing by a swimming pool. They are wearing various styles of swimwear: one in a blue and white star pattern, one in a white and blue two-piece, one in a red two-piece, and one in a white, blue, and red two-piece. They are standing on a terracotta tile deck.

**lumi**  
COLLECTIVE  
LET YOUR LIGHT SHINE!

**VISIT US AT  
BOOTH TC03  
FOR YOUR  
FREE GIFT.**



# MARIIA

Dance Distributors: BalTogs and Watercolour  
22840 Savi Ranch Parkway  
Yorba Linda, CA 92887  
Ph: (714) 970-0462

E-mail: [esther.szassz@outlook.com](mailto:esther.szassz@outlook.com)  
Web site: [www.dancedistributors.com](http://www.dancedistributors.com)

## **MARIIA**

### SILHOUETTES FOR THE MODERN BALLERINA

Mariia reimagines classic dancewear with prestige pieces that fuel you, move with you, and define you. Fusing beauty with innovation for flawless performance so you can dance boldly and achieve greatness.

## **DANCE DISTRIBUTORS --- DANCEWEAR BUYING REIMAGINED**

Join Dance Distributors to find all your top brands under one roof. From ballet to tween fashion, we are committed to providing you with 20+ launches per year. Boost your sales with digital marketing tools, live inventory, and on-demand showrooms. Refresh your store selection any time of the year, manage your orders and stay on top of your deliveries.

### **Show Special**

- 1) Schedule an appointment with Dance Distributors' using the Calendly app and be eligible for a raffle to win \$250 credit towards your full priced order. A winner will be selected daily!
- 2) Place order(s) for \$750 or more on either Mariia, BalTogs, or Watercolour orders before the end of day February 10<sup>th</sup>, and receive 10% off the amount. Lumi is only sold at full price, but if you order \$750 or more of Lumi, orders for the other brands will be eligible for 10% no minimum.

CONTACT: MICHAEL LEE email: [mlee@dancedistributors.com](mailto:mlee@dancedistributors.com) phone: 732-233-3908

**Virtual and Baltimore Exhibitor**



# MARIIA

SILHOUETTES FOR THE MODERN BALLERINA

**VISIT US AT BOOTH TC02  
FOR A CHANCE TO WIN \$250.**



Merlet North America  
565 Roma Court Naples,  
FL 34110  
Ph: +33 (0) 5 55 70 32 17  
E-mail: merletusa@merletdance.com  
Web site: www.merletdance.com

### **Merlet North America**

At Merlet Dance, for almost 50 years our craftsmen have designed and hand made our shoes in our workshop in France. Our know-how, energy and passion for dance is in every shoe. With all of our most popular styles readily available in our local Florida fulfilment center, we bring to you our unique quality, comfort & durability all year round.

### **Show Specials**

New to Merlet? Get a free pointe shoe bags & a fitting mat with your first order!  
30 day terms\* & free shipping\*.

### **Pointe & Ballroom Shoe Offer:**

Buy 20 pairs + get 2 free pairs  
Buy 50 pairs + get 8 free pairs

Buy 30 pairs + get 5 free pairs  
Buy 70+ pairs = get 12 free pairs

SOFT BALLET SHOE OFFER - 10% discount

### **Terms & Conditions :**

New To Merlet offer cannot be cumulated with any other offer. Pointe, Soft Ballet & Ballroom shoe offers can be cumulated but stay separate. Free shoes will be the lowest priced models. Essential ballroom & Autumn Winter collection show ballroom shoes are included in the offer. Only one order per offer per account permitted. Dancewear Expo Show Special offer only for participants at the Dancewear Expo Virtual or Baltimore Shows.

Order date limit : February 6, 2023. \*Payment terms\* : 50% 30 days from delivery, 50% 60 days from delivery. Free shipping for all orders over 600\$. \*subject to credit approval

# MERLET

MAÎTRE CHAUSSONNIER DEPUIS 1974



[www.merletdance.com](http://www.merletdance.com)



**HANDMADE IN  
FRANCE**

# MiGARU®

Migaru  
Calle Peninsule #2960  
Mexico: Guadalajara, Jalisco 44540  
Ph: +523331511815  
E-mail: [op@migarudance.com](mailto:op@migarudance.com)  
Web site: [www.migarudance.com](http://www.migarudance.com)

### **Profile:**

MiGARU is a brand that is distinguished by its variety of unique designs and excellent quality in sewing and fabrics. We are the brand in Mexico with the best textile technology (SUPPLEX® certificate from Lycra®)

MiGARU is a high end brand created by dancers for dancers. With two warehouses, one in Mexico to satisfy the American market and the other in Spain for the European market. MiGARU is a dancewear brand that finds the perfect balance between femininity and strength. Dancer dedication to reach perfection

Created by dancers, MiGARU understands the needs to feel comfortable, secure, moving freely in any attire. With the best textile technology (SUPPLEX® certificate from Lycra®) and the excellent quality in sewing in their own factory, MiGARU is helping dancers from all over the world in reaching perfection, breathing dance.

From high fashion to the ballerina lifestyle.

Distinguished by the variety in their fashionable collections, the MiGARU Design team, trained in Milan, learned from the best of Haute Couture to bring the most trendy cuts and colors to dance schools and stages.

Sharing the passion of dance and fashion

With personalized attention and marketing support to any distributor channel, MiGARU is also compromised with all their partners and involved in fair trade and ethical manufacturing.

High quality, fashion and fair market value make MiGARU the best choice for dancers in love with fashion.

### **Show Specials:**

15% off on orders placed during the show, 10% off on your first order

**Baltimore Exhibitor**

\*15% on orders placed during the show.

\*10% on your first order.

**MiGARU®**  
[www.migarudance.com](http://www.migarudance.com)





Mondor Ltd  
785 Rue Honore-Mercier  
Saint-Jean-Sur-Richelieu  
Quebec, ON J2X 3S2  
Ph: 450-347-5321  
E-mail: [mondor@mondor.com](mailto:mondor@mondor.com)  
Web site: [www.mondor.com](http://www.mondor.com)

## **Mondor**

Mondor develops high performance tights and competition apparel, which meet the specific needs of athletes specializing in dance, figure skating and gymnastics. Mondor also provides comfortable, fashionable tights designed for active women. Mondor is comprised of an authentic, passionate team of people who, day after day, pursue the quest for excellence by developing exceptional quality products.

**Baltimore Exhibitor**



# Nikolay<sup>®</sup>

## Made for Legends

Nikolay® (Nikolay LLC)

USA Telephone: (407) 237-9598

Wholesale: orders@nikolay-world.com

Customer Service: csr1@nikolay-world.com

B2B: www.nikolay-world.com

Address: 7003 Presidents Dr Suite 600 Orlando, FL 32809

Nikolay® brand was introduced exclusively in the USA in 2019. We have created a complete line of products from the best materials in the world, from Italian tight manufacturers and highest quality European raw materials, to working with the top pointe shoe factory in the world.

In one of the most challenging years for our company, we still have shown a tremendous growth and persevered through shipping issues, all of this of course due to the support of our incredible retailers all across the US.

We thank you for your continued support and trust.

In 2022, with the events that shook and continues to shake the world, we have taken measures to protect our retailers from backlash with the origin of products and diversify our roster of manufacturers. We have opened a brand new manufacturing facility in Europe, where we are now producing our leotards, heat retention, tutus and many more items.

Your beloved pointe shoes are still made in the same factories and with the same hands as you have come to love bringing you the quality you expect from Nikolay®.

What makes us different from other brands?

Our pointe shoe manufacturer and design team, our core, is located in the world center of Classical Ballet, with factories in constant contact with professional dancers, teachers, students and lovers of ballet every day. These pointe shoe makers are absolutely the best in the world, immersed in the culture of dance. These masters work directly with the dancers; that experience doesn't happen in almost any other company in the world. Our approach is to select the best of everything: materials, designers, marketers and sales teams around the world.

### **IMPORTANT ANNOUNCEMENT**

With the rising costs of living, shipping, as well as import duties on goods, we must announce another price increase:

A \$5 increase on all pointe shoes: This price increase will be implemented in two stages:

March 1 2023 increase of \$2.50 on each pair of pointe shoes (MSRP will go up to \$125)

May 1 2023 increase of \$2.50 on each pair of pointe shoes (MSRP will stay at \$125)

This increase is done in two stages to help our retailers to make extra margin on our goods for the first quarter purchasing.

**Virtual and Baltimore exhibitor**

# Nikolay®

Made for Legends

DANCEWEAR  
**EXPO**

**PLATINUM SPONSOR**

## DANCEWEAR EXPO 2023 SHOW SPECIALS

ORDER AMOUNT	DISCOUNT	TERMS	AND SOMETHING EXTRA
\$1,000	3% (**5%)	Place by 2-17-23	*PLUS ONE TIME 3% COUPON TO BE USED IN MAY 2023 with no minimum order required
\$2,000	5% (**7%)	Place by 2-17-23	*PLUS ONE TIME 5% COUPON TO BE USED IN MAY 2023 with no minimum order required
\$3,000	7% (**9%)	Place by 2-17-23	*PLUS ONE TIME 7% COUPON TO BE USED IN MAY 2023 with no minimum order required
\$5,000	8% (**10%)	Place by 2-17-23	*PLUS ONE TIME 8% COUPON TO BE USED IN MAY 2023 with no minimum order required
\$7,000	10% (**12%)	Place by 2-17-23	*PLUS ONE TIME 10% COUPON TO BE USED IN MAY 2023 with no minimum order required
\$14,000	10% (**12%)	Place by 2-17-23	*PLUS ONE TIME 10% COUPON TO BE USED IN MAY 2023 with no minimum order required. As well as a standing discount of 8% on any order until Dec 31 2023

\*Coupon is non-transferable \*Coupon can only be used for one order in the month of May 2023

\*Coupon code will be emailed to you on May 1 2023

**\*\*ADD 2% TO YOUR DISCOUNTS IF YOU ARE PAYING YOUR INVOICE AT TIME OF SHIPPING**



Oh La La Dancewear / Chic Ballet  
640 Washington Street  
Eden, NC 27288  
Ph: 336-627-3360

E-mail: [wholesale@ohlaladancewear.com](mailto:wholesale@ohlaladancewear.com)

Web site: [www.ohlaladancewear.com](http://www.ohlaladancewear.com)

### **Oh La La Dancewear**

A little bit of edge and a lot of sass, Oh La La Dancewear is known for bright and colorful prints, amazing fabric quality, and unique designs. There is something for every dancer for class, stage and convention to stand out!

**Oh La La Dancewear** was born from the knowhow of a retailer that was in need of fashion that never stops evolving. A unique range of tops and bottoms is complete with colorful and fashion forward leotards. Each and every collection release offers the ability to mix and match styles within the collection. High quality is at the core of our business and regular releases to keep your store looking fresh and re-stocked!

**Chic Ballet Dancewear Co.** was created as a secondary line by Jennifer Clark, the creator and owner of Oh La La Dancewear. As an extension of her convention wear brand, she decided to extend her designs in the ballet market. Chic Ballet offers that special garment, be it a photoshoot or an audition, or just a Saturday class where you want to spice up your wardrobe. Beautifully designed leotards, skirts, and trash pants and shorts are just a few of the amazing designs that can be selected with the release of a new collection.

### **Show Special**

FREE SHIPPING ON NEW COLLECTIONS WHEN YOU SPEND \$500+ PER SHIPMENT  
SALE COLLECTIONS RECEIVE AN EXTRA 10% OFF  
ORDERS MUST BE PLACED BY FRIDAY, FEBRUARY 10, 2023

**Baltimore Exhibitor**



*Oh la la*  
DANCEWEAR



[www.ohlaladancewear.com](http://www.ohlaladancewear.com)



Pillows For Pointes Inc.  
840 Lincoln Avenue #5  
Bohemia, NY 11716  
Ph: 800-269-3844 Fax: 866-462-6556  
E-mail: [info@pillowsforpointes.com](mailto:info@pillowsforpointes.com)  
Web site: [www.pillowsforpointes.com](http://www.pillowsforpointes.com)

### **Pillows For Pointes**

For The Dedicated Dancer.

Since 1992, Pillows For Pointes has offered an innovative selection of finest quality dance accessories. We began with 4 products. Now, in our 30th year, we offer over 125 items that are designed and tested to improve and enhance a dancers performance.

Our company has more styles, materials, and sizes of toe protection for the ballerina than any other supplier in the world. In addition to our Toe Pillows, we offer products for the Irish dancer and a complete line of Minishooz- miniature dance shoes with key rings.

### **Show Special**

10 % off show order on all styles and price list products; offer expires at the end of show; account status must be current. We accept all major credit cards.

LARGEST SELECTION OF TOE PILLOWS • DANCE SHOE PILLOWCASES IN 20 COLORS

COME BY TO SAY HELLO  
AND SAVE 10% OFF  
YOUR SHOW ORDER!

Save On All Styles  
and All Price List Products!

- Offer Expires at the End of Show
- Account Status Must Be Current
- We Accept All Major Credit Cards

*Pillows*<sup>®</sup>  
FOR POINTES



1-800-269-3844

[www.pillowsforpointes.com](http://www.pillowsforpointes.com)

©2023 Pillows For Pointes, Inc.

PERSONAL FOOT PRODUCTS • LARGEST COLLECTION OF MINISHOOZ<sup>®</sup> KEY RINGS



PointePeople  
1212 S. Napier Blvd – suite #119 –  
PMB314  
Naperville, IL 60540  
Ph: 201-898-0515  
E-mail: [hello@pointepeople.com](mailto:hello@pointepeople.com)  
Web site: [www.pointepeople.com](http://www.pointepeople.com)

**PointePeople**

PointePeople is a dance brand on a mission to build products and a community that educate, empower, and enrich dancers all over the world. PointePeople believes in doing good: doing good for yourself and doing good for others.



Pretty Girl Cosmetics  
1526 SW 13th Ct  
Pompano Beach, FL 33069  
Ph: 863-606-8453  
E-mail: [info@prettygirlcosmetics.com](mailto:info@prettygirlcosmetics.com),  
Web site: [www.prettygirlcosmetics.com](http://www.prettygirlcosmetics.com)

### **Pretty Girl Cosmetics**

Pretty Girl Cosmetics is a leading cheerleading and dance makeup brand offering sweat-proof stage makeup to retailers, drill teams, cheerleaders, and dance studios. Pretty Girl Cosmetics promises nothing but a remarkable shopping experience with affordable makeup that you can customize to suit your wishes and needs! Our mission is to save our customers time, money, and worries by giving them an option to do all their shopping in one place! Shop from a wide variety of stage performance makeup, apparel, accessories, jewelry and more! With our large selection of stage makeup and Patented ColorOn Instant PressOn Eye Shadows, Pretty Girl Cosmetics ensures that customers have uniformity in a long lasting makeup application.

**Show Special:** Stage Fit Palettes are \$20

**Baltimore Exhibitor**





## QT Intimates

QT Intimates (A division of Montelle Intimates)

9250 ave. du Parc – Suite 500

Montreal, QC Canada H2N 1Z2

Ph: 514-383-3739

Rep Email: [bbond74651@aol.com](mailto:bbond74651@aol.com)

Rep Ph: 856-979-9575

Website: [www.qtbras.com](http://www.qtbras.com)

### **Profile:**

With a long history of quality and service, Q-T Foundations is proud of the customer relationships and following that have been developed over the past 75 years. The motivation at QT Intimates has always been simple, but relentless – make a product that does the job it's supposed to do – be supportive and stylish – and make it better year after year.

We support woman from all walks of life with an intimate apparel collection for dancers, exercisers, brides and moms. Fashion and fit are our main objective, because wearing the right bra gives a woman confidence inside and out.

Complete line of dance undergarments including: Bras, bodyliners, panties, accessories, and more.

### **SHOW SPECIAL for QT INTIMATES of division of MONTELLE INTIMATES**

\$ 300.00 + 5 % discount

\$ 500.00 + 7 % discount

\$ 1,000.00 + 10% discount

The order must be placed through your sales representative any time from January 4, 2023 through February 28, 2023. The order MUST BE SHIPPED by 4/25/2023. Please write "SHOW SPECIAL" on your order to receive DISCOUNT.

**Baltimore Exhibitor**



**Rhino-Stone LLC**

22620 Farm Road

Peculiar, MO 64078

Ph: 844-4RHINO1

E-mail: [rhinostoneboard@gmail.com](mailto:rhinostoneboard@gmail.com)

Web site: [www.rhinostoneboard.com](http://www.rhinostoneboard.com)

**Rhino-Stone**

This new product that we have patented is designed to take on the difficulties of making amazing and complex dance costumes. Not only can the Rhino-Stone board handle one project, it's materials and durability allow you to keep making costumes over and over without glue sticking to the surface. Rhinestoning has never been easier or more fun and we hope you give our board a try!

**Show Special**  
**5% off Your First Order**  
**with a new B2B Account**

# The new way to rhinestone is here

Meet your rhinestoning assistant, Rhino-Stone Board. A patented designed product created by a costume designer and dance mom to help save you time on your rhino-stoning projects.

## **SLIM DESIGN**

Thin space saving design perfect for on the go projects while traveling and easy to store!

## **NON-STICK SURFACE**

Created with a non-sticky material allowing you to rhinestone away without the sticky mess from glue!

## **SLEEVE SLOT**

Integrated slot designed to make rhinestoning sleeves, tights, leggings, etc., less time-consuming!

## **HANG-DRY HOOK**

The integrated hook was designed to allow garments to hang-dry straight with no slipping.



AVAILABLE IN FOUR SIZES:  
MINI, CHILD, ADULT, XL  
**[rhinestoneboard.com](http://rhinestoneboard.com)**



RP Collection / FLX  
77 West Washington Street Suite 1100  
Chicago, IL 60602  
Ph: 312-332-7200 Fax: 312-701-5500  
E-mail: [wholesale@rpcollection.com](mailto:wholesale@rpcollection.com)  
Web site: [www.rpcollection.com](http://www.rpcollection.com)  
[www.flxstretchtraining.com](http://www.flxstretchtraining.com)

## **RP Collection**

The RP Collection has been inspiring dancers to lead extraordinary lives for over 20 years. Russian Pointe is world renowned for its original product: precisely fitting pointe shoes that blend traditional artistry and modern technology to best support student and professional ballet dancers. RP's growing product line includes a variety of dance shoes, apparel and accessories, made with the latest fabrics and manufacturing techniques. Each new product reflects the company's established standards of excellence for outstanding comfort, fit, and elegance. Russian Pointe provides market-leading customer care to both retailers, including a unique array of educational resources, and state-of-the-art logistics and IT integration to provide consistent quality and efficient delivery.

## **FlexiStretcher (FLX) by RP Collection**

FLX: FLX is a brand of innovative performance equipment and training for stretch, strength and recovery used by leading dancers, athletes and experts in Pilates, yoga and physical therapy, worldwide. Renowned for its original product the Flexistretcher®, FLX products and training techniques were originally created to keep up with the daily demands of professional ballerinas, but proven beneficial for athletes or individuals looking to enhance flexibility and challenge their fitness goals. Beyond innovative wellness products, FLX enables users to obtain optimal results in mobility and strength through its educational resources, including ACE approved courses that adhere to a researched training approach of flexibility conditioning techniques.

**Virtual and Baltimore Exhibitor**



Silky Dance / Legwear International  
10 Grange Close

Clover Nook Industrial Park  
Alfreton, Derbyshire UK DE55 4QT

Ph: +44 (0) 1773 713200

E-mail: [rachel@legwearinternational.co.uk](mailto:rachel@legwearinternational.co.uk),  
[emily@legwearinternational.com](mailto:emily@legwearinternational.com)

Web site: [www.legwearinternational.com](http://www.legwearinternational.com)

## **Silky Dance**

Having established the Silky brand as a key player in the UK hosiery industry, we decided to create the Silky Dance range with the same mission – to use our extensive knowledge and experience to make the best quality dance tights and undergarments at the lowest possible prices.

16 years later, being one of the fastest-growing brands in the industry, our expanding catalogue of products come in various shades to accommodate every dancer.

We have a vast range that suits customers with every budget and pride ourselves in our incredibly soft and durable tights and invisible and seamless undergarments. Our aim is to be your 'go to' for any specialty products and great quality basics.

## **Show Special**

Free shipping on orders placed at the shows.

# SILKY Dance

THE DANCE TIGHTS &  
UNDERGARMENTS SPECIALISTS

SHOW SPECIAL

**FREE**  
US SHIPPING



Dance  
Underwear



Dance  
Tights



Dance  
Socks



**LEGWEAR  
INTERNATIONAL**

Since 1996

**FOR SALES CONTACT:**

**EMILY@LEGWEARINTERNATIONAL.COM**

Silky Dance brand is exclusively distributed to  
dance retail customers by Legwear International.

**WWW.LEGWEARINTERNATIONAL.COM/USA**



TRADE PRICES



WORLDWIDE  
SHIPPING



GUARANTEED  
QUALITY



EASY TO USE  
WEBSITE



SAFE & SECURE  
PAYMENTS



So Danca  
328 South Military Trail  
Deerfield Beach, FL 33442  
Ph: 800-269-5099 Fax: 888-355-0525  
E-mail: [sodanca@sodanca.com](mailto:sodanca@sodanca.com)  
Web site: [www.knowdance.com](http://www.knowdance.com)

### **So Danca**

Só Dança is more than an industry leader in dancewear and shoes. We are a global brand that represents the entire community of people passionate about the art of dance. Whether for the studio or stage, Só Dança offers a full line of products designed to move and made to last.

*So Danca*<sup>™</sup>

# JOIN US

Be a part of inspiring the next generation  
with Só Dança and New York City Ballet  
principal dancer, Tiler Peck.

WELCOME TO  
THE TILER PECK  
COLLECTION

*Love,  
Tiler*



@sodancausa  
[www.weknowdance.com](http://www.weknowdance.com)





Suffolk Dance LLC  
845 N. Mill Street – Suite 100  
Lewisville, TX 75057  
Ph: 972-316-6907 Fax: 972-459-5553  
E-mail: [orders@suffolkdance.com](mailto:orders@suffolkdance.com)  
Web site: [www.suffolkdance.com](http://www.suffolkdance.com)

**Suffolk Dance LLC**

Professional companies, dancers, and retailers around the world look to Suffolk for our unparalleled pointe shoes, modern dancewear, and innovative accessories. We believe in fair-trade practices, handcrafted workmanship, the best materials, and personal service. Made in England and the USA.

Products:

Traditional Handmade Pointe Shoes  
Fashion and Basic Leotard Collections  
Ballet focused Accessories and Tights

**Baltimore Exhibitor**

# Suffolk<sup>®</sup>



**Join us for our Seminars:**

*Pointe Readiness with Dr. Emily Love- Saturday 2pm*  
*Introduction of New Pointe Shoe Collection- Saturday 4pm*  
*Pointe Readiness with Dr. Emily Love- Sunday 2pm*

**suffolkdance.com**

**(972)316-6907**



Sweet Wink  
3950 Long Beach Road  
Long Beach, NY 11558  
Ph: 516-509-7823  
E-mail: [hello@shopsweetwink.com](mailto:hello@shopsweetwink.com)  
Web site: [www.shopsweetwink.com](http://www.shopsweetwink.com)

## **Profile:**

Sweet Wink is a lifestyle children's clothing and accessories brand designed by a mother/daughter duo in New York City. We aim to make every day a party with our colorful and celebratory collection of tutus, tees, and hair accessories.

Why do we do it? We believe every day is a party worth celebrating! So throw on your tutu and grab your favorite glitter bow because it's time to get this party started!



SWEET  
*wink*

BOOTH 513  
TUTUS, CAPES, TIARAS & MORE  
[SHOPSWEETWINKWHOLESALE.COM](http://SHOPSWEETWINKWHOLESALE.COM)



Superior Stretch Products

P.O. Box 12551

Glendale, AZ 85318

Ph: 480-272-1634

E-mail: [paul@superiorstretch.com](mailto:paul@superiorstretch.com)

Web site: [www.superiorstretch.com](http://www.superiorstretch.com)

### **Profile:**

Superior Stretch Products has been the number one source for Stretch, Strength, Balance and Recovery products made specifically for the Dancer since 2012. Join our network of over 250 Dancewear Retail Store Partners by registering your store on the secure B2B Wholesale section of our website.

Superior Stretch Products has been the number one source for Stretch, Strength, Balance and Recovery products made specifically for the Dancer since 2012. Join our network of over 250 Dancewear Retail Store Partners by registering your store on the secure B2B Wholesale section of our website.

### **Show Special**

12% OFF EXPO ORDERS THRU FEB 28, 2023

USE COUPON CODE: EXPO WHEN PLACING ORDERS ONLINE AT:

[superiorStretch.com/wholesale/](http://superiorStretch.com/wholesale/)

**Non-Exhibiting Sponsor**

# SUPERIOR<sup>TM</sup> STRETCH Products



**12% OFF EXPO ORDERS THRU FEB 28, 2023**

**USE COUPON CODE: EXPO WHEN PLACING ORDERS  
ONLINE AT: [SuperiorStretch.com/wholesale/](https://www.SuperiorStretch.com/wholesale/)**



Centuries-old tradition meets cutting-edge technology  
in the pointe shoes handcrafted for every expression.  
See for yourself in booths 104-106.

[virtisse.com](http://virtisse.com)

**virtisse**<sup>®</sup>  
HANDCRAFTED FOR DANCE



Virtisse  
241 King Manor Drive  
King of Prussia, PA 19072  
Ph: 610-239-6440  
E-mail: [irene@virtisse.com](mailto:irene@virtisse.com)  
Web site: [www.virtisse.com](http://www.virtisse.com)

**Profile:**

The Virtisse story begins with three women, each one from a different background but each one with a unified vision, to create the best pointe shoes for a new generation of ballet dancers using science and industry expertise. We are a woman run and woman owned company with a passion for ballet. Our mission is to collectively shine a new and unconventional light on the ballet world and embrace those who may feel and experience non-conforming treatment. Together, along with our shared and beloved dance community, we present Virtisse.

Our criteria for the best products rests on function, durability and foremost the ability for performing artists to articulate and freely express their movement. Modern science, creativity and an understanding production technology are our guiding principals. We design and produce durable and beautiful pointe shoes that are anatomically correct and take into consideration the physiology of today's ballet dancers.

Virtisse is the realization of our vision and we are thrilled to bring these extraordinary products to the dance world.

**Show Special**

Orders of min \$500 - 5% discount and free shipping  
\$2000 - 7% discount and free shipping  
\$4000 -10% discount and free shipping

**Baltimore Exhibitor**





# enchantment

Centuries-old tradition meets cutting-edge technology  
in the pointe shoes handcrafted for every expression.  
See for yourself in booths 104-106.

[virtisse.com](http://virtisse.com)

**virtisse**  
HANDCRAFTED FOR DANCE

CUSTOM  
*by* M I



Your Design Your Way





Wear Moi LLC  
3352 N Broadway  
Chicago, IL 60657  
Ph: 773-850-3119 Fax: 773-901-2167  
E-mail: [usa@wearmoi.com](mailto:usa@wearmoi.com)  
Web site: [www.wearmoi.us](http://www.wearmoi.us)

### **Wear Moi**

Wear Moi is a French based luxury dancewear brand, design by dancers for dancers. 2023 is an exciting year for Wear Moi as many exciting and ambitious projects are coming soon! Our products have stood the test of time with proven designs that fit and functions perfectly with dancers' movement and offers unique styling with long lasting color and dependable stitching.

The Wear Moi brand has grown tremendously from a leotard-based company to a world-wide supplier of dancewear offering various product categories such as fashion, basics and regulation uniforms for schools' requirements; an extensive men's and boy's collection; knitwear; tights; skirts; handbags and backpacks; hair accessories, and a full range of soft shoes and pointe shoes.

At Wear Moi our philosophy is we listen, we adapt, we deliver. Our strong brand recognition has allowed the company to flourish on five continents. Our flagship location in Chicago, IL serves as a hub for in-stock distribution throughout North, Central and South America.

### **Show Special**

25% CUSTOM by MOI (Select inspirations from CUSTOM by MOI)

15% Vesta (All colors)

15% Black Sale (Any product made in total black, excludes CUSTOM by MOI and Première Collection)

10% Wear Moi Première Collection (Three per size per color)

\*Valid for order placed during Dancewear Expo 2023, with your sales representative. Not valid for online orders. May not be combined with other current promotions.

**Baltimore Exhibitor**



# Wear Moi

2023 SHOW SPECIALS\*

**CUSTOM by MOI**

*(Select inspirations from  
CUSTOM by MOI)*

**25% OFF**

**VESTA**

*(All colors)*

**15% OFF**

**BLACK SALE**

*(Any product made in total black)  
Excludes CUSTOM by MOI  
and Première Collection*

**15% OFF**

**PREMIÈRE  
COLLECTION**

*(Three per size per color)*

**10% OFF**

\*Valid for order placed during Dancewear Expo 2023, with your sales representative. Not valid for online orders. May not be combined with other current promotions.



Yumiko USA  
214 West 39<sup>th</sup> Street  
New York, NY 10018  
Ph: 212-560-9487

E-mail: [newyorkboutique@yumiko.com](mailto:newyorkboutique@yumiko.com)

Web site: [www.yumiko.com](http://www.yumiko.com)

**Profile:**

Founded in 2002, Yumiko creates long-lasting, great-fitting dance and athletic wear of the highest quality.

Drawing on Asian, European and American fashion influences, Yumiko offers a modern perspective on the dancewear industry with its expansive color options and style catalog.

Devoted to quality, customer satisfaction and sustainable practices, Yumiko is recognized across the world for both brand integrity and innovative design.

**Baltimore Exhibitor**

# Nikolay®

Made for Legends



WORLD  
CLASS  
COSTUMES

OFFICIAL SPONSOR



DANCEWEAR  
**EXPO**

Ph. 407-237-9598  
orders@nikolay-world.com

 nikolayworld



nikolay-world.com



Thank you to our exhibitors and attendees for their continued support and participation.  
We hope that you are as excited about 2023 as we are and we wish everyone continued success.

We will be announcing our 2024 Show schedule very soon.

*Roger Leung & Sandy Askin*

DANCEWEAR  
**EXPO**